

M:\SPICE4\files\astabil\_1  
\*SPICE\_NET

-----  
\*INCLUDE AD6.LIB  
\*INCLUDE NONLIN.LIB  
\*INCLUDE DEVICE.LIB  
\*INCLUDE DIODE2.LIB  
\*INCLUDE DIODE4.LIB  
-----

Includerea bibliotecilor de componente

-----  
.TRAN 0.1U 1M  
-----

Definirea tipului de analiză

-----  
.VIEW TRAN V(6)  
.VIEW TRAN V(5)  
-----

Declararea rezultatelor simulării

-----  
R2 5 2 300K  
R1 5 1 100K  
D1 2 6 DN4148  
D2 6 1 DN4148  
R4 7 3 10K  
R3 5 11 10K  
R7 7 0 100K  
R6 7 6 120K  
C1 5 0 1N  
V1 0 9 DC 18  
V2 10 0 DC 18  
R5 12 6 1  
DZ1 6 8 ZN758A  
DZ2 0 8 ZN758A  
X1 11 3 12 10 9 UA741  
-----

Descrierea circuitului

-----  
.END

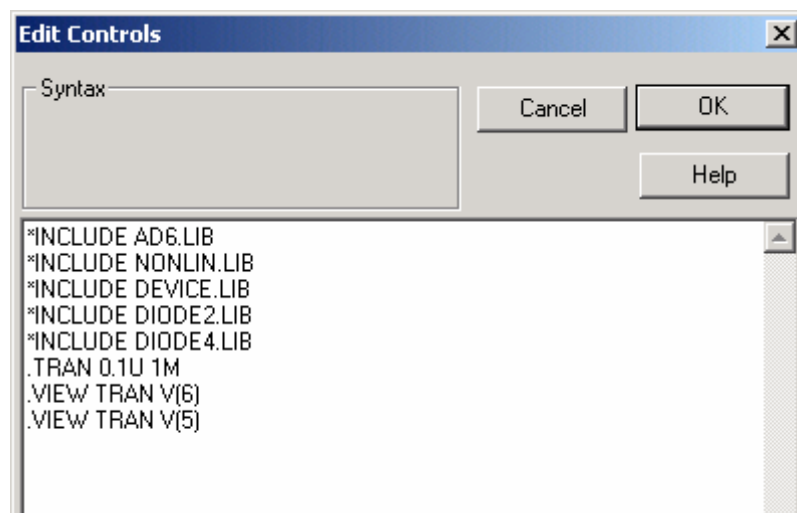

## Etapele de realizare a unui produs electronic

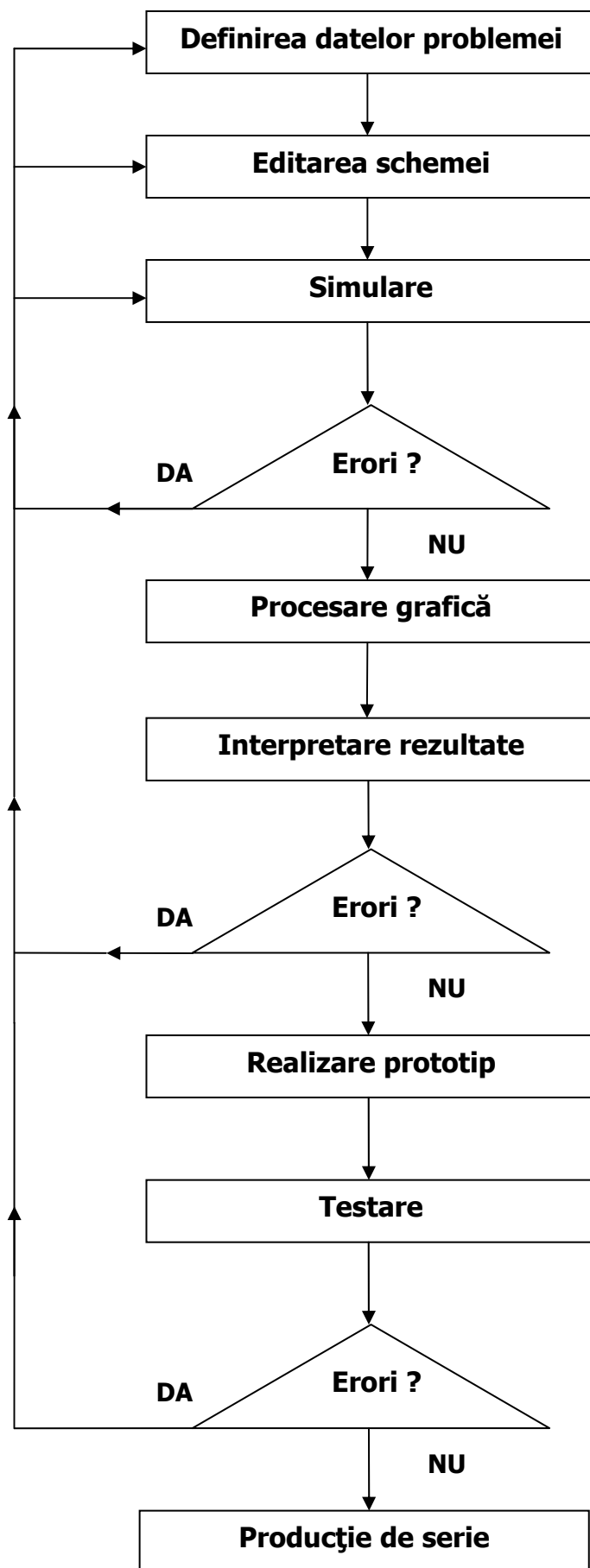

**SPICE**  
=  
Simulation **P**rogram with **I**ntegrated **C**ircuit **E**mphasis

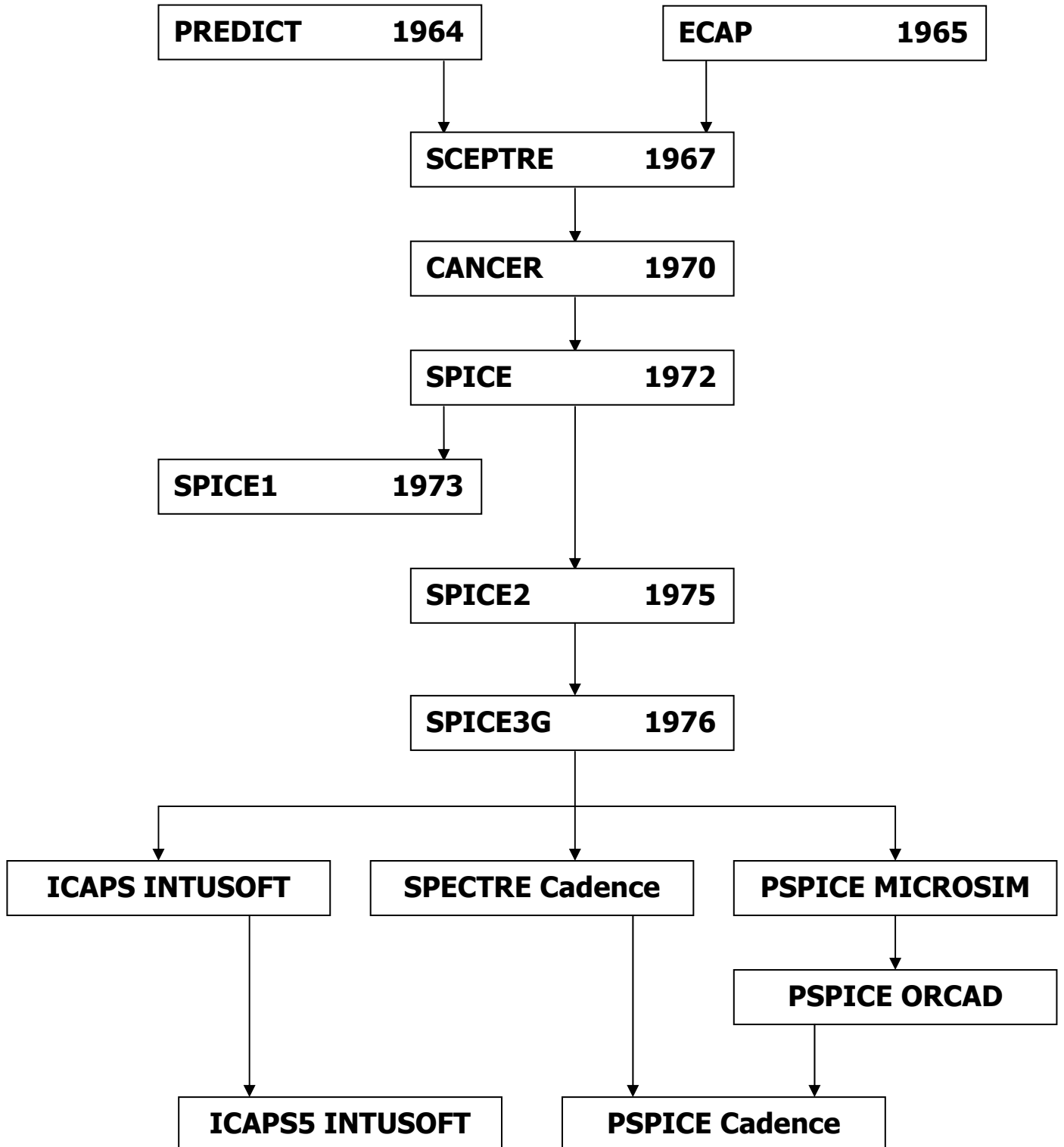

# Circuit astabil cu amplificator operațional cu ciclu asimetric

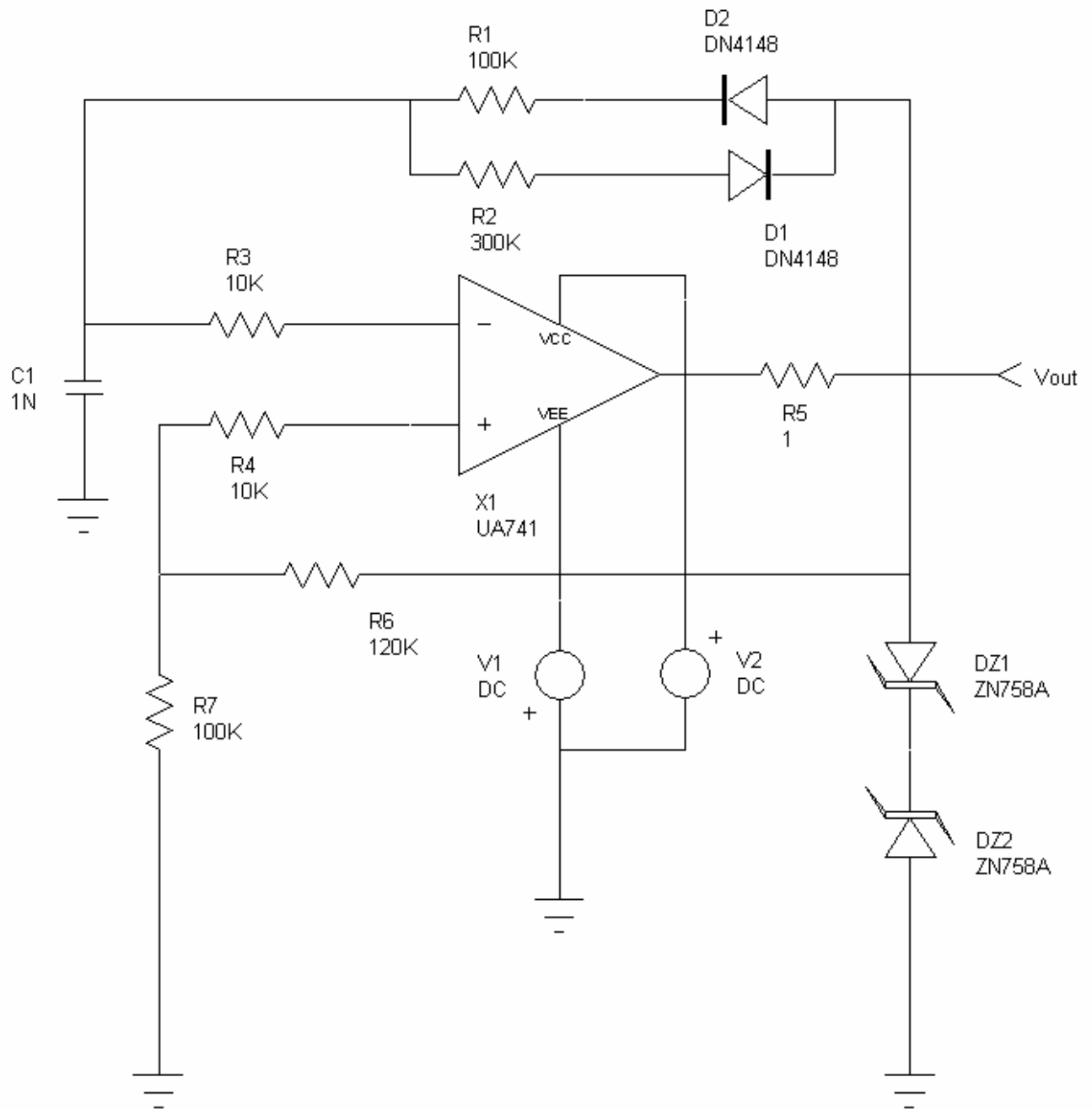

# Rezultatele simulărilor

$C_1 = 5nF$

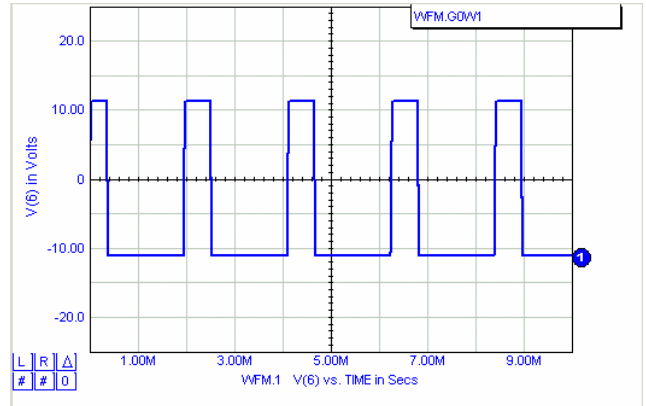
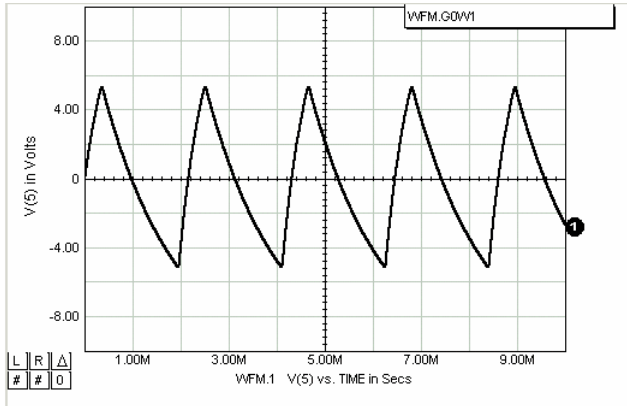

$C_1 = 10nF$

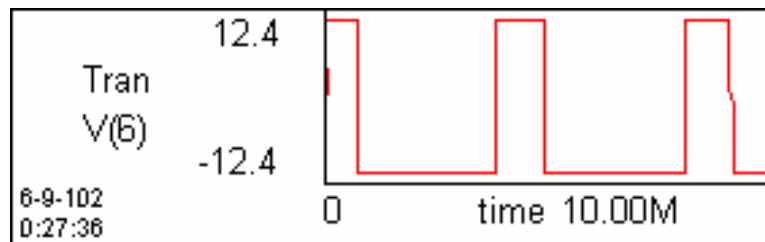
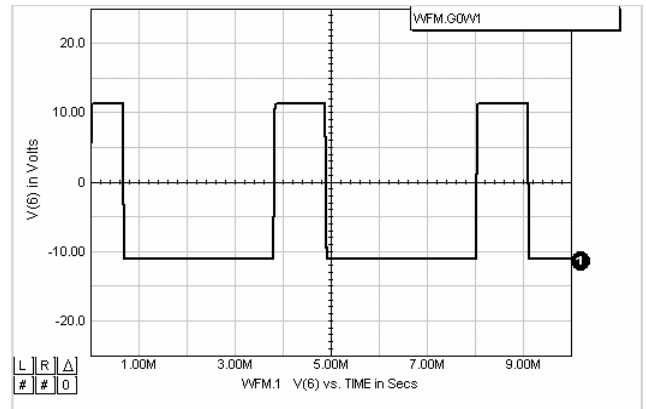
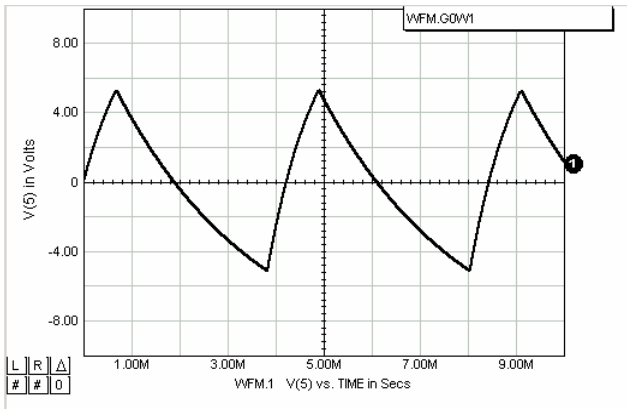

$C_1 = 10nF$

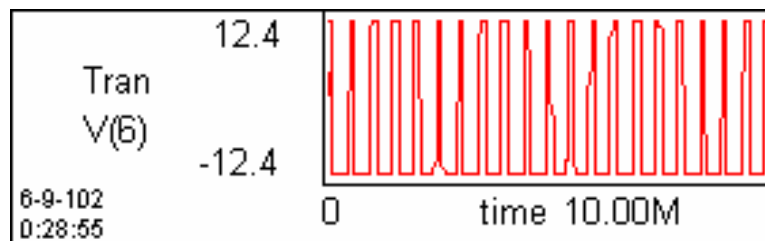

$C_1 = 1nF$

## R1=100k R2=1000k

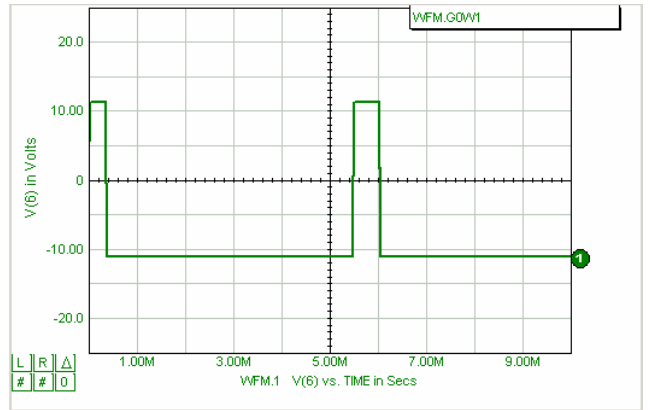
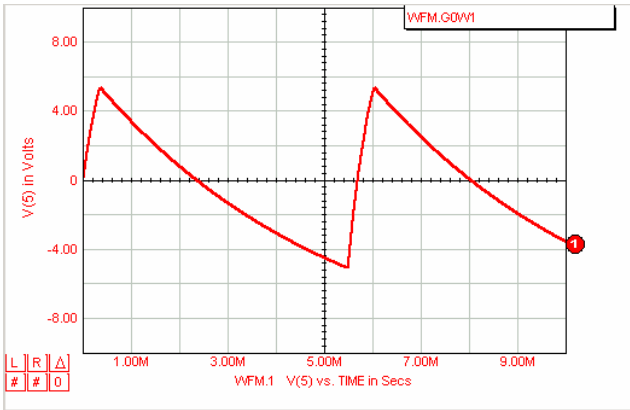

## R1=10k R2=1000k

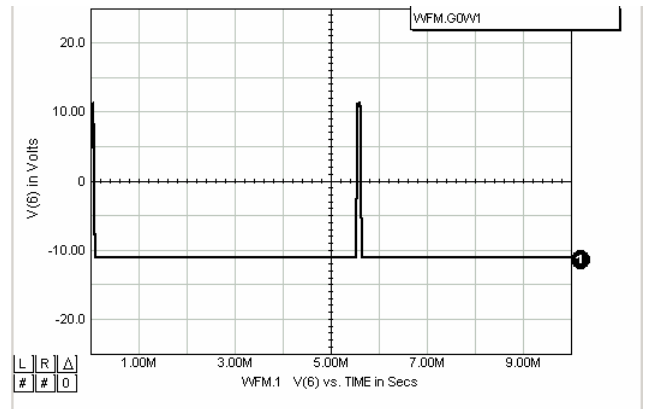
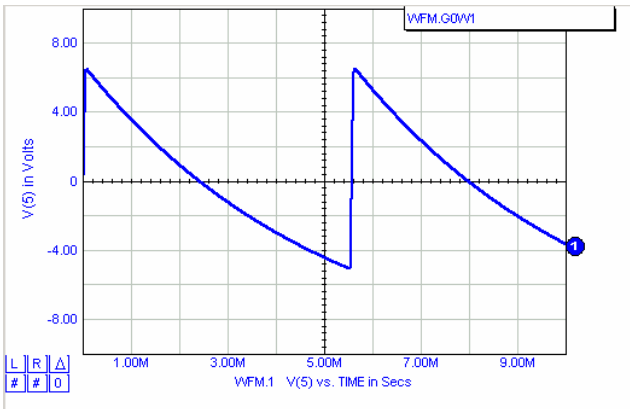

## R1=1k R2=1000k

